

Operating manual

Recirculating Coolers

FL7006 FLW7006

FL11006 FLW11006

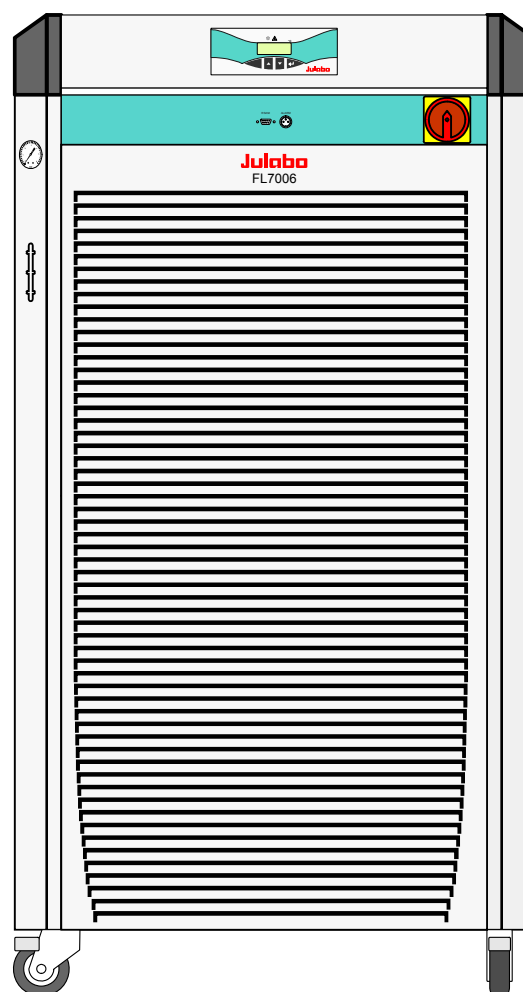

Julabo
Innovative Temperature Technology

JULABO Labortechnik GmbH
77960 Seelbach / Germany

☎ +49 (0) 7823 / 51-0
📄 +49 (0) 7823 / 24 91
✉ info@julabo.de
🌐 www.julabo.de

Changes without prior notification reserved
Printed in Germany
1.951.4828 BE0 10/08 Druck: 28.10.2008
19514828_FL70xx_FL110xx.doc

Congratulations!

You have made an excellent choice.

JULABO thanks you for the trust you have placed in us.

This operating manual has been designed to help you gain an understanding of the principles of operating and possibilities of our circulators. For optimum utilization of all functions, we recommend that you thoroughly study this manual prior to beginning operation.

EC Conformity



The products described in the operating instructions conform to the requirements of the following European guidelines:

Low voltage regulations with respect to legal harmonization of the member countries concerning electric devices for use within certain voltage limits.

EMC guideline with respect to legal harmonization of the member countries concerning electromagnetic compatibility.

Julabo

JULABO Labortechnik GmbH
Eisenbahnstr. 45
77960 Seelbach / Germany

Quality Management System



The JULABO Quality Management System:

Development, production and distribution of temperature application instruments for research and industries conform to the requirements according to DIN EN ISO 9001:2000.

Certificate Registration No. 01 100044846

TABLE OF CONTENTS

1. Use according to intended purpose.....	4
1.1. Description.....	4
2. Operator responsibility – Safety recommendations.....	4
2.1. Handling.....	4
2.2. Use.....	5
2.3. Disposal.....	5
3. Technical specifications.....	6
3.1. Warning functions and safety installations.....	8
3.2. Cooling water connection.....	9
4. Safety notes for the user.....	10
4.1. Safety recommendations.....	10
5. Unpacking and checking.....	11
6. Installation.....	11
6.1. Tubing.....	13
7. Operating controls and functional elements.....	14
8. Operating procedures.....	16
8.1. Bath fluids.....	16
8.2. Power connection.....	16
8.3. Filling.....	17
8.4. Switching on / Start - Stop.....	17
8.5. Setting the feed pressure.....	18
8.6. Setting the temperatures.....	18
8.7. AUTOSTART ON / OFF.....	18
8.8. Remote control: activate – deactivate.....	19
9. Safety installations.....	19
9.1. Excess temperature protection.....	19
9.2. Low level protection.....	19
10. Troubleshooting guide / Error messages.....	20
11. Electrical connections.....	22
12. Remote control.....	23
12.1. Setup for remote control.....	23
12.2. Communication with a PC or a superordinated data system.....	23
12.3. List of commands.....	24
12.4. Status messages.....	24
12.5. Error messages.....	25
13. Cleaning / repairing the unit.....	26
13.1. JULABO Service – Online remote diagnosis.....	28
13.2. Draining.....	29
14. Adequate storing of operating manual.....	29
15. Warranty conditions.....	30

1. Use according to intended purpose

JULABO recirculating coolers have been designed for temperature application to specific fluids. The pump connections can be used for cooling applications in an external circuit at a constant temperature.

	JULABO recirculating coolers are not conceived for direct temperature application to food and luxury articles or pharmaceutical and medico-technical products. Direct temperature application means: Unprotected contact of the object with the bath medium (bath fluid).
---	---

1.1. Description

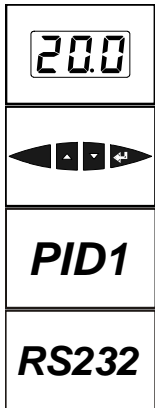

- ☑ The recirculating coolers are operated via the splash-proof keypad. The implemented microprocessor technology allows to set and to store the setpoint that can be indicated on the LED temperature display.
- ☑ The PID temperature regulation is used to withdraw heat from the bath fluid by means of the cooling machine and to automatically regulate the required need.
- ☑ Electrical connections:
 1. The serial interface RS232 allows modern process technology without additional interface.
 2. Alarm output for external alarm message.
- ☑ Manually adjustable by-pass (handwheel) to reduce the pump capacity (e. g. for glass equipment).

2. Operator responsibility – Safety recommendations

The products of JULABO Labortechnik GmbH warrant a safe operation if installation, operation and maintenance is carried out according to common safety regulations. This section informs you about potential dangers that may arise from operating the recirculating cooler and also mentions the most important safety precautions.

The operator is responsible for the qualification of the personnel operating the units.

The operator should be constantly informed about the dangers involved with their job activities as well as preventive actions.

Make sure all persons expected to carry out operation, installation and maintenance of the unit read and understand the safety information and operating instructions.

When using hazardous materials, the circulator may only be operated by persons that are absolutely familiar with these materials and the circulator. These persons must be fully aware of possible risks.

If you have any questions concerning the operation of your unit or the information in this manual, please contact us!

Contact JULABO Labortechnik GmbH
Eisenbahnstraße 45
77960 Seelbach / Germany

☎ +49 7823 51-0
☎ +49 7823 2491

✉ info@JULABO.de
🌐 www.JULABO.de

2.1. Handling

You received a product conceived for industrial use. Nevertheless, avoid strikes to the housing, vibrations, damages to the keypad foil (keys, display) or contamination.

Make sure the product is regularly checked for proper condition. Regularly check (at least every 2 years) the proper condition of the mandatory, warning, prohibition and safety labels.

Take care that the mains supply features a low impedance to avoid any negative affects on the

instrument being operated in the same mains.

This unit is designed for operation in a controlled electromagnetic environment. This means that transmitting devices (e.g. cellular phones) should not be used in the immediate vicinity. Magnetic radiation may influence other units with components susceptible to magnetic fields (e.g. a monitor). We recommend to keep a minimum distance of 1 m.

Permissible ambient temperature: max. 40 °C, min. 5 °C.

Permissible relative air humidity: 50 % (40 °C).

Do not store in an aggressive atmosphere. Protect from contaminations. Do not expose to sunlight.

Appropriate Operation

Only qualified personnel is authorized to perform configuration, installation, maintenance and repairs of the recirculating cooler. Untrained personnel should be instructed by trained personnel.



2.2. Use

For the use according to the intended purpose, special material requirements have to be respected (bath fluids). Only use non-acid and non corroding materials. Observe all warnings for the used materials (bath fluids) and the respective instructions (safety data sheets).

Only use the unit in well ventilated areas. (see page 11).

The recirculating coolers are not for use in explosive atmosphere

When using hazardous materials, **the user must** attach the enclosed safety labels to the front of the unit so they are well visible.

Warning label W00: Colors: yellow, black		Danger area. Attention! Observe instructions. (operating manual, safety data sheet)
Mandatory label M018 Colors: blue, white		Carefully read the user information prior to beginning operation Scope: EU
Semi S1-0701 Table A1-2 #9		Carefully read the user information prior to beginning operation Scope: NAFTA

Observe the instructions in the manuals for instruments of a different make that you connect to the circulator, particularly the respective safety recommendations. Also observe the pin assignment of plugs and technical specifications of the products.

2.3. Disposal

This unit contains the refrigerants R134a or R404A – at this time considered not to have any negative effects on the ozone layer. However, during the long operating period of the unit, disposal prescriptions may change. So only qualified personnel should take care of disposal.

Valid in EU countries:

Directive 2002/96/EC of the European Parliament and of the Council of 27 January 2003 on waste electrical and electronic equipment (WEEE).

This directive requires electrical and electronic equipment marked with a crossedout trash can to be disposed of separately in an environmentally friendly manner.

Contact an authorized waste management company in your country.

Disposal with household waste (unsorted waste) or similar collections of municipal waste is not permitted!

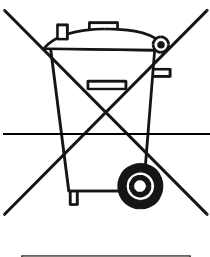

3. Technical specifications

Recirculating Cooler		FL7006	FLW7006
Cooling		air cooled	water cooled
Working temperature range	°C	-20 ... +40	-20 ... +40
Temperature stability	°C	±0.5	
Temperature selection:		digital	
via key pad		indication on LED-DISPLAY	
remote control via personal computer		indication on monitor	
Temperature indication:		LED-DISPLAY	
Resolution	°C	0.1	
Temperature control		PID 1	
Temperature sensor		Pt 100	
Excess temperature protection		85 °C - fixed value	
Low liquid level protection		float switch	
Cooling capacity	°C	<u>+20 0 -10</u>	<u>+20 0 -10</u>
Medium: Mixture water-glycol	kW	7.0 5.5 3.0	7.4 6.0 3.1
Cooling compressor		1-stage	
Refrigerant		R404A	
Electrical connections:			
Computer interface		RS232	
Alarm output		for external alarm signal	
Circulating pump:			
discharge, max.	at 0 bar	l/min	60
pressure, adjustable	at 0 Liter	bar	0.5 ... 6.0
Feed pressure indication		bar	Manometer
Filling level indicator			sight glass
Filling volume	from ... to	liters	25 ... 35
Dimensions (WxLxH)		cm	60x76x115
Weight		kg	252
Ambient temperature range		°C	5 ... 40
Return flow temperature		°C	80 max.
Cooling water			
Flow rate at 20 °C inlet temperature		l/min	11.6
IP class according to IEC 60 529			IP 21
Mains power connection	400 V/3P/50 Hz	V/ Hz	360-440/3Phases/50
Current input at 230 V		A	14
Mains power connection	230 V/3P/60 Hz	V/ Hz	197-242/3Phases/60
Current input at 220 V		A	23

All measurements have been carried out at: rated voltage and frequency,
ambient temperature: 20 °C

Recirculating Cooler		FL11006	FLW11006
Cooling		air cooled	water cooled
Working temperature range	°C	-20 ... +40	-20 ... +40
Temperature stability	°C	±0.5	
Temperature selection:		digital	
via key pad		indication on LED-DISPLAY	
remote control via personal computer		indication on monitor	
Temperature indication:		LED-DISPLAY	
Resolution	°C	0.1	
Temperature control		PID 1	
Temperature sensor		Pt 100	
Excess temperature protection		85 °C - fixed value	
Low liquid level protection		float switch	
Cooling capacity	°C	<u>+20</u> 0 -10	<u>+20</u> 0 -10
Medium: Mixture water-glycol	kW	11.0 7.5 5.0	11.5 8.0 5.1
Cooling compressor		1-stage	
Refrigerant		R404A	
Electrical connections:			
Computer interface		RS232	
Alarm output		for external alarm signal	
Circulating pump:			
discharge, max.	at 0 bar	l/min 60	60
pressure, adjustable	at 0 Liter	bar 0.5 ... 6.0	0.5 ... 6.0
Feed pressure indication		bar	Manometer
Filling level indicator			sight glass
Filling volume	from ... to	liters	25 ... 35
Dimensions (WxLxH)		cm	60x76x115
Weight		kg	248
Ambient temperature range		°C	5 ... 40
Return flow temperature		°C	80 max.
Cooling water			
Flow rate at 20 °C inlet temperature		l/min	-----
Flow rate at 20 °C inlet temperature			18.2
IP class according to IEC 60 529			IP 21
Mains power connection 400 V/3P/50 Hz	V/ Hz	360-440/3Phases/50	360-440/3Phases/50
Current input at 230 V	A	17	17
Mains power connection 230 V/3P/60 Hz	V/ Hz	207-253/3Phases/60	207-253/3Phases/60
Current input at 230 V	A	27	-----

All measurements have been carried out at: rated voltage and frequency,
ambient temperature: 20 °C

3.1. Warning functions and safety installations

Excess temperature protection	85 °C - fixed value
Low liquid level protection	float switch
Alarm message	optical + audible (permanent)
Excess temperature - Warning function	75 °C
Overload protection	for compressor and pump motor
Classification according to DIN 12876-1	class I

Environmental conditions according to IEC 61 010-1:

Use only indoor.

Altitude up to 2000 m - normal zero.

Ambient temperature: +5 ... +40 °C

Air humidity:

Max. rel. humidity 80 % for temperatures up to +31 °C,

linear decrease down to 50 % relative humidity at a temperature of +40 °C

Max. mains fluctuations of ±10 % are permissible.

The unit corresponds to Class I

Overvoltage category II

Pollution degree 2



Caution:

The unit is not for use in explosive atmosphere

Standards for interference resistance according to EN 61326-1

This unit is an ISM device classified in Group 1 (using high frequency for internal purposes) Class A (industrial and commercial range).

3.2. Cooling water connection

Only for water cooled models - FLW:

Cooling water pressure (IN / OUT)	max.	4,5 bar
Difference pressure (IN - OUT)		2 bar to 4,5 bar
Flow rate on FLW 7000x	typical	11,6 l/min
Flow rate on FLW 11006	typical	18,2 l/min
Cooling water temperature		<20 °C

Recommended quality of cooling water:

pH – value	7,5 to 9,0
Sulfate [SO ₄ 2-]	< 100 ppm
Hydrocarbonate [HCO ₃ -] / Sulphate [SO ₄ 2-]	> 1 ppm
Hardness [Ca ²⁺ , Mg ²⁺] / [HCO ₃ -]	> 0,5 dH
Alkalinity	60 ppm < [HCO ₃ -] < 300 ppm
Conductivity	< 500 µs / cm
Chloride (CL-)	< 50 ppm
Phosphate (PO ₄ 3-)	< 2 ppm
Ammonia (NH ₃)	< 0,5 ppm
Free Chlorine	< 0,5 ppm
Ferri Ions (Fe ³⁺)	< 0,5 ppm
Mangano Ions (Mn ²⁺)	< 0,05 ppm
Carbon dioxide (CO ₂)	< 10 ppm
Hydrosulfide (H ₂ S)	< 50 ppm
Content of oxygen	< 0,1 ppm
Algae growth	impermissible
Suspended solids	impermissible



Notice:

Danger of corrosion of heat exchanger due to unsuitable quality of cooling water.

- Due to its high content of lime hart water is not suitable for cooling and causes calcination of the heat exchanger.
- Ferrous water or water containing ferrous particles will cause formation of rust even in heat exchangers made of stainless steel.
- Chlorous water will cause pitting corrosion in heat exchangers made of stainless steel.
- Due to its corrosive characteristics distilled and deionized water is unsuitable and will cause corrosion of the bath. .
- Due to its corrosive characteristics sea water is not suitable.
- Due to its microbiological (bacteria) components which settle in the heat exchanger untreated and unpurified river water and water from cooling towers is unsuitable.
- Avoid particulate matter in cooling water.
- Avoid putrid water.

4. Safety notes for the user



In addition to the safety warnings listed above, warnings are posted throughout the manual. These warnings are designated by an exclamation mark inside an equilateral triangle. „Warning of a dangerous situation (Attention ! Please follow the documentation).“

The danger is described according to an alarm keyword.
Read and follow these important instructions.



Warning:

Describes a possibly highly dangerous situation. If this is not avoided, serious injury and danger to life could result.



Caution:

Describes a possibly dangerous situation. If this is not avoided, slight or minor injuries could result.

A warning of possible damage can also be contained in the text.



Notice:

Describes a possibly harmful situation. If this is not avoided, the product or anything in its surroundings can be damaged.

4.1. Safety recommendations

Follow the safety recommendations to prevent damage to persons or property. Further, the valid safety instructions for working places must be followed.



- Only connect the unit to a power socket with earthing contact (PE – protective earth)!
- The power supply plug serves as safe disconnecting device from the line and must be always freely accessible.
- Place the instrument on an even surface on a pad made of **non-inflammable** material.
- Make sure you read and understand all instructions and safety precautions listed in this manual before installing or operating your unit.
- Never operate the unit without bath fluid in the bath.
- Do not drain the bath fluid while it is hot or cold!
Check the temperature of the bath fluid prior to draining (by switching the unit on for a short moment for example).
- Employ suitable connecting tubing.
Make sure that the tubes are securely attached.
- Never operate damaged or leaking equipment.
- Always turn off the unit and disconnect the mains cable from the power source before performing any service or maintenance procedures, or before moving the unit.



- Always empty the bath before moving the unit.
- Never operate equipment with damaged mains power cables.
- Risk of injury for hands. Close cover carefully.

5. Unpacking and checking

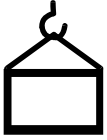

Unpack the recirculating cooler and accessories and check for damages incurred during transit. These should be reported to the responsible carrier, railway, or postal authority, and a request for a damage report should be made. These instructions must be followed fully for us to guarantee our full support of your claim for protecting against loss from concealed damage. The form required for filing such a claim will be provided by the carrier.

← Lifting device for transportation by crane see page 14

6. Installation

- Place the unit on an even surface on a pad made of **non-flammable** material. Using the castors (10a, 10b) move the unit to the intended location.
For better stability, apply the holding breaks on the front casters (10a).
- Cooling machine, pump motor and electronics produce intrinsic heat that is dissipated via the venting openings.! Never cover these openings!
- Keep at least 20 cm of open space on the front and rear venting grids.
- The place of installation should be large enough and provide sufficient air ventilation to ensure the room does not warm up excessively because of the heat the instrument radiates to the environment. (Max. permissible ambient temperature: 40 °C).
With regard to a disturbance in the cooling loop (leakage), the guideline EN 378 prescribes a certain room space to be available for each kg of refrigerant.
> For 0.48 kg of refrigerant R404A, a room space of 1 m³ is required.

Example: model FL7006 with 1.5 kg filling quantity of refrigerant R404A = 3,13 m³ volume

Rear view Example: FLW7006

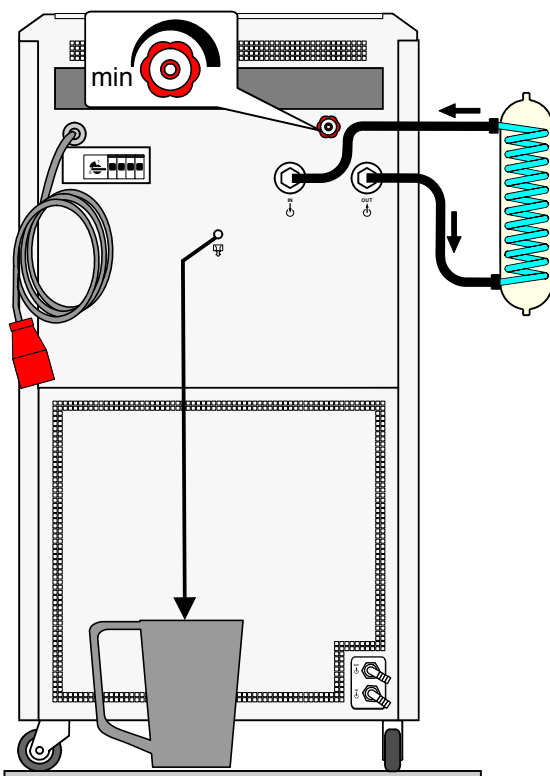

- Connect the tubings for cooling the external system to the pump connectors M16x1 for feed and return (14) on the rear of the recirculating cooler.
- Connect a piece of tubing to the overflow connector (15) and drain into a suitable vessel, which always has to be placed lower than the exit „Overflow“.
- Turn the adjusting valve (13) counter-clockwise to set the lowest manometric pressure.
- Do not set up the unit in the immediate vicinity of heat sources and do not expose to sun light.
- Before operating the unit after transport, wait about one hour after setting it up. This will allow any oil that has accumulated laterally during transport to flow back down thus ensuring maximum cooling performance of the compressor.

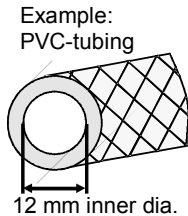
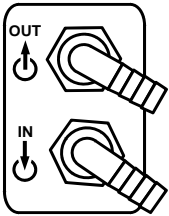

- Only water cooled models - FLW:
Ensure circulation of cooling water by connecting the tubing to cooling water inlet (IN) and outlet (OUT) on the rear (18) of the recirculating cooler.

Cooling water see page 9.

Cooling water connectors G3/4" external thread

Tubing 12 mm inner dia. tubing

IN Cooling water inlet

- OUT Cooling water outlet

Even high quality heat exchangers as they are installed in our equipment can be damaged by unsuitable cooling water.

The quality of the cooling water depends on the local conditions.

The heat exchanger may become leaky due to corrosion or it may become clogged due to particulate matter



Notice: Cooling water circuit

Risk of oil leaking from the cooling circuit (compressor) of the recirculating cooler into the cooling water in case of a fault in the circuit!

Observe the laws and regulations of the water distribution company valid in the location where the unit is operated.



Caution: Pump pressure

- Determine and check the max. admissible pressure for the external circuit before putting the unit into operation. The max. pressure is determined by the weakest element in the circuit (e. g. glass equipment).
- Securely attach all tubing to prevent slipping.



Notice: Flood hazard!

In case the system to be cooled is located at a higher level than the recirculating cooler, take note of bath liquid flowing back when the unit is switched off.

Return flow safety device

Should the filling volume of the bath tank not be sufficient, prevent the liquid from flowing back by using shut-off valves..

Order No.	Description	Suitable for
8 970 458	Shut-off valve G 1¼"	FL(W) 7006/11006

The following questions shall help to recognize possible dangers and to reduce the risks to a minimum.

- Are all tubes and electrical cables connected and installed?
Note:
sharp edges, hot surfaces in operation, moving machine parts, etc.
- What to do when a dangerous substance was spilled on or in the unit?
Before starting to work, obtain information concerning the substance and determine the method of decontamination.

6.1. Tubing



Caution:

- Employ suitable connecting tubing.
- Make sure that the tubing is securely attached.
- Avoid sharp bends in the tubing, and maintain a sufficient distance from surrounding walls.
- Regularly check the tubing for material defects (e.g. for cracks).
- Preventive maintenance: Replace the tubing from time to time.

Recommended tubing:

Order No.	Description	Suitable for
8930325	1 m Reinforced tubing 1" inner dia. (-40 ... +120°C)	FL(W) 7006/11006

Tubing insulation

8930425	1 m Insulation, 35 mm inner dia.	Reinforced tubing 1" inner dia.
---------	----------------------------------	---------------------------------

Tube clamps

8970484	2 Tube clamps, size 5	Reinforced tubing 1" inner dia.
---------	-----------------------	---------------------------------

7. Operating controls and functional elements

Example: FL7006 Front view

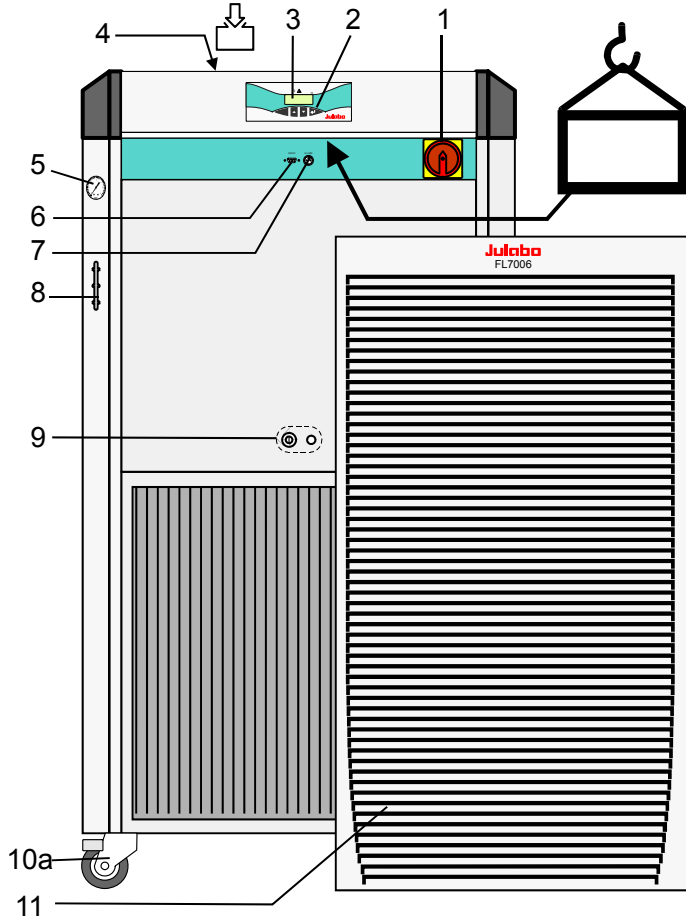

Rear view

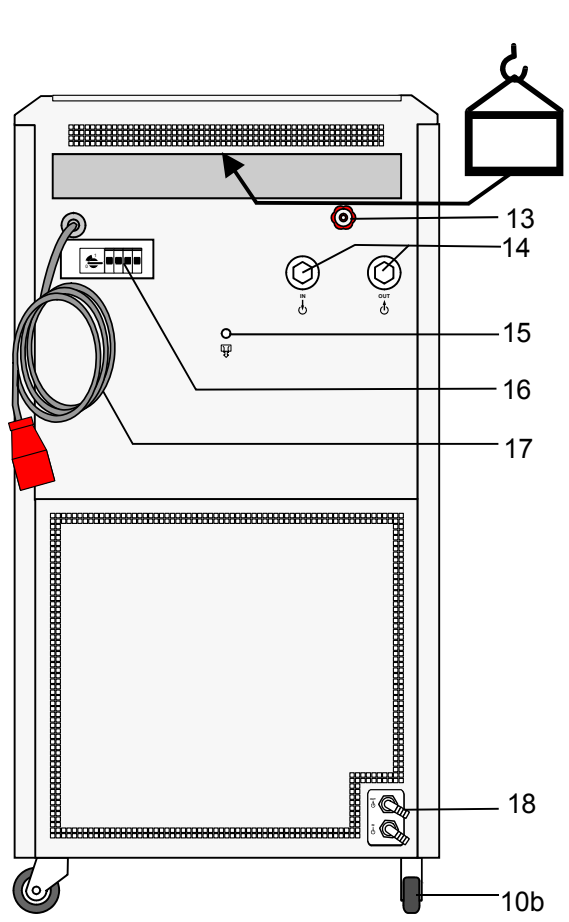

Draufsicht

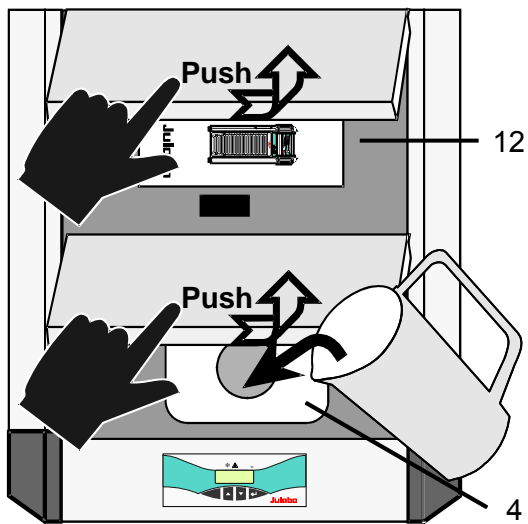







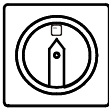
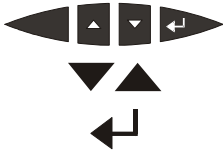

4 Protection lid for fill in opening

12 Protection lid for storing place of operating manual

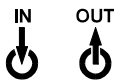

Lifting device for transportation by crane

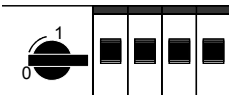
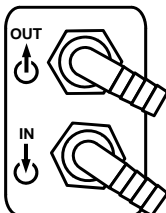
- 1  Mains power switch
- 2.0  **Keypad**, splash-water protected
- 2.1 Edit keys (set point increase or decrease)
- 2.2 Enter key Store set point value / parameter
- 3.0 **Indication**
- 3.1  LED temperature display
- 3.2  Control indicator – Cooling
- 3.3  Control indicator – Alarm
- 4 Protection lid for fill in opening
- 5 Feed pressure indication: Manometer
- 6  RS232
Interface RS232: remote control via personal computer
- 7  Alarm output (for external alarm signal)
- 8 Filling level indication
- 9 Drain tap with drain port
- 10a Castor with brake (at the front)
- 10b Castor without brake (at the back)
- 11 Venting grid, removable
- 12 Protection lid for storing place of operating manual
- 13 Feed pressure adjusting valve
- 14  Pump connector OUT – pressure pump
Pump connector IN– Return
 FL/FLW7006 G 1¼“
 FL/FLW11006 G 1¼“
- 15  Overflow connector
- 16  Mains circuit breakers (resettable)
1 Motor protection circuit breaker for compressor motor
2 Mains circuit breakers (resettable) 4 A (for Electronics)
2 Mains circuit breakers (resettable) 10 A (for Pump motor)
- 17 Mains power cable with plug
- 18  Only water cooled models
IN Cooling water inlet
OUT Cooling water outlet
 G3/4" external thread
 12 mm inner dia. tubing

8. Operating procedures

8.1. Bath fluids



Caution:

No liability for use of other bath liquids!

Please contact JULABO before using other than recommended bath fluids. JULABO takes no responsibility for damages caused by the selection of an unsuitable bath fluid

Do not use alcohols.

Water:

The quality of water depends on local conditions.

- Due to the high concentration of lime, hard water is not suitable for temperature control because it leads to calcification in the bath.
- Ferrous water can cause corrosion - even on stainless steel.
- Chloric water can cause pitting corrosion.
- Distilled and deionized water is unsuitable. Their special properties cause corrosion in the bath, even in stainless steel.

Water: - No liability for use with water.

Danger of freezing at working temperatures $<5\text{ }^{\circ}\text{C}$.

Mixture water -glycol:

Strictly observe the safety data and handling instructions from the manufacturer.

The proportion of water might evaporate by and by. Check the mixing ratio regularly and refill water if necessary.

Recommended bath fluids:

Bath fluids	Temperature range
JULABO Thermal G	-30 °C ... 80 °C
mixture water/glycol (50:50)	-30 °C ... 50 °C
soft/decalcified water	+5 °C ... 80 °C

Order No.	Description	Quantity
8 940 124	JULABO Thermal G	10 liters
8 940 125	JULABO Thermal G	5 liters

8.2. Power connection



Caution:

- Only connect the unit to a power socket with earthing contact (PE – protective earth)!
- The power supply plug serves as safe disconnecting device from the line and must be always freely accessible.
- Never operate equipment with damaged mains power cables.
- Regularly check the mains power cables for material defects (e.g. for cracks).
- We disclaim all liability for damage caused by incorrect line voltages!

Check to make sure that the line voltage matches the supply voltage specified on the identification plate.

8.3. Filling



Notice:

Risk of injury for hands. Close cover carefully.

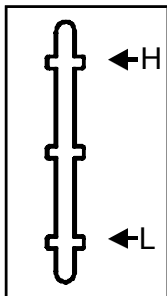
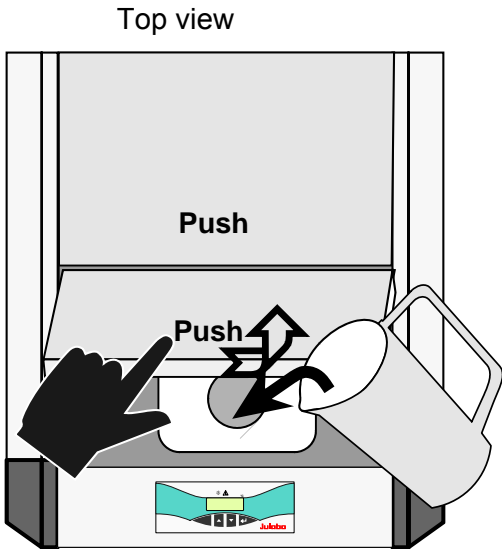

Take care that no liquid enters the interior of the circulating cooler.

- ① Connect the tubing from the external system to the pump connectors and check for leaks



Respect instructions from page 11 to page 13!

- ① Check to make sure that the drain tap (9) is closed.

- Unlock and open lid of fill in opening (4) by slightly pushing.
- Fill in tempering fluid up to marking „H“ of the filling level indicator.

- Turn the mains switch (1) on (Switching on - see page 17)
- Switch on unit. To do so press button  for approx. 4 seconds.
- Tempering fluid is pumped into the externally connected system. Refill fluid up to marking „H“.
- The recirculating cooler is ready for operation.

8.4. Switching on / Start - Stop

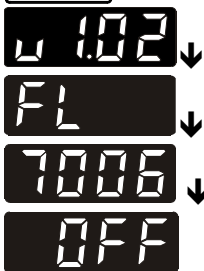
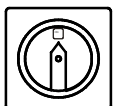

Switching on:

The recirculating cooler is turned on and off with the mains switch. The unit performs a self-test. All segments of the 4-digit LED temperature DISPLAY and all indicator lights will illuminate (as illustrated on the left).

Then the software version and the type of unit is indicated. Examples: (v 1.02) (FL7006)

The display "OFF" indicates the unit is ready to operate (standby mode).

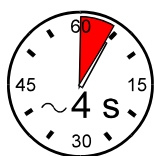

Start: Press enter  for about 4 seconds.

The LED temperature DISPLAY indicates the actual bath temperature.

Stop: 1. Press enter  for about 4 seconds.

2. Wait until the LED display stops blinking!

3. Turn the unit off with the mains power switch.

8.5. Setting the feed pressure

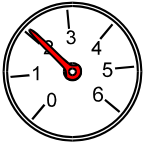

Set the max. permissible feed pressure (example: 2 bar) by slowly closing the adjusting valve (13) on the rear and looking at the manometer (5).

- ⓘ The max. pressure is determined by the weakest element in the circuit (e. g. glass equipment).

8.6. Setting the temperatures

Factory setting: 25 °C

- ⓘ Setting can be carried out in the start/stop condition.

1. Press one of the keys ▼ ▲ for a short moment.
The setpoint value instead of the actual value is indicated on the display for about 8 seconds.
The value can now be changed.
2. Change value:
Press ▲ to set a higher value.
Press ▼ to set a lower value.
Keep the keys depressed for the value to change fast.
3. Press enter ↵ to store the value.

8.7. AUTOSTART ON / OFF

The recirculating cooler has been configured and supplied by JULABO according to N.A.M.U.R. recommendations. This means for the start mode, that the unit must enter a safe operating state after a power failure (non-automatic start mode). This safe operating state is indicated by „OFF“ on the LED temperature display. A complete shutdown of the main functional elements such as compressor and circulating pump is effected simultaneously.

Should such a safety standard not be required, the AUTOSTART function (automatic start mode) may be activated, thus allowing the start of the circulator directly by pressing the mains power switch

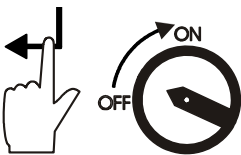

Keep depressed enter ↵ and turn on the unit with the mains power switch.

For a short while the LED DISPLAY indicates the effective start mode:

AOn ⇒ AUTOSTART on. **AOf** ⇒ AUTOSTART off.



Warning:

For supervised or unsupervised operation with the AUTOSTART function, avoid any hazardous situation to persons or property.

The circulator does no longer conform to N.A.M.U.R. recommendations.

8.8. Remote control: activate – deactivate

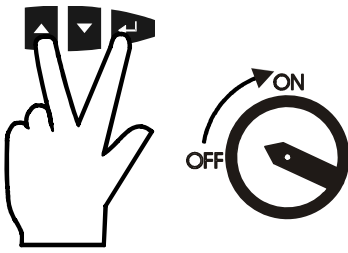

(Interface OFF)

10FF

(Interface On)

10n

102

FL

7006

rOFF

The recirculating cooler is to be prepared for remote control by a personal computer via the serial interface RS232. Set the interface item from >IOFF< to >ION<.

Remote control: activate – deactivate:

- Switch off recirculating cooler by pressing the mains switch and wait approx. 5 seconds.
- Keep depressed the keys ▲ and enter ↵ simultaneously and turn on the unit with the mains power switch.

>I OFF< No remote control via RS232 (Factory setting)

>I On< Remote control via RS232

- ⓘ The software version and the type of unit is indicated (see example on the left).

The display "rOFF" indicates the unit is ready to be operated via remote control.

9. Safety installations

9.1. Excess temperature protection



This safety installation is independent of the control circuit.

When the temperature of the bath fluid has reached the safety temperature (85 °C), a complete shutdown of the compressor and pump is effected.

The alarm is indicated by optical and audible signals (continuous tone) and on the LED-DISPLAY appears the error message "Error 14".

9.2. Low level protection



This safety installation is independent of the control circuit.

If the low liquid level protection device is triggered, a complete shutdown of the compressor and circulating pump is effected.

The alarm is indicated by optical and audible signals (continuous tone) and on the LED-DISPLAY appears the error message

"Error 01".

- ⓘ Turn off the unit with the mains switch, refill bath fluid and turn the unit on again!



Caution:

For refill always use the same bath fluid type that is already in the bath.



Notice:

Check the low liquid level protection device at least twice a year!

To execute a functional test, drain the liquid until the alarm for low liquid level is triggered. Refill liquid afterwards.

10. Troubleshooting guide / Error messages

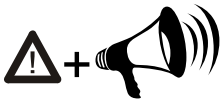

Whenever the microprocessor electronics registers a failure, a complete shutdown of the compressor and circulating pump is performed. The alarm light "⚠" illuminates and a continuous signal tone sounds. The LED temperature display indicates the cause for the alarm in form of a code.



Press enter  to quit the audible signal.

E 01

- The recirculating cooler is operated without bath fluid, or the liquid level is insufficient. Replenish the bath tank with the bath fluid.
- Tube breakage has occurred (insufficient filling level due to excessive bath fluid pumped out). Replace the tubing and replenish the bath tank with the bath fluid.

E 05

Cable of the working temperature sensor interrupted or short-circuited.

E 12

Error in A/D converter

E 14

The return temperature is above the switch-off value of the high temperature protection (85°C). Check dimensioning of application. Use a stronger recirculating cooler if necessary.

E 51

The pressure sensor of low pressure side (evaporation pressure) is faulty, short-circuited or has a line interruption. Have the repair done by a specialist.

E 52

The pressure sensor of high pressure side is faulty, short-circuited or has a line interruption. Have the repair done by a specialist.

E 53

The suction gas temperature sensor is faulty, short-circuited or has a line interruption. Have the repair done by a specialist.

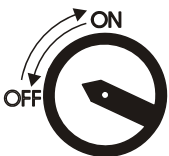

After eliminating the malfunction, press the mains power switch off and on again to cancel the alarm state. If the unit cannot be returned to operation, contact an authorized service station.



Warning without a complete shutdown of the unit

Excess temperature warning starting at 75 °C

The return temperature soon reaches the swith-off value of the high temperature protection (85 °C).



Cooling of the condenser is affected. (see page **Fehler! Textmarke nicht definiert.**)

- Clean air-cooled condenser.
- Check the flow rate and cooling water temperature on water-cooled condenser.

If the unit cannot be returned to operation, contact an authorized JULABO service station.

Disturbances that are not indicated.

Overload protection:: a) for cooling machine

b) for pump motor

After a short cooling interval, the unit will automatically start running.

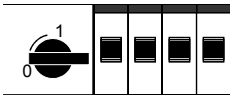

Mains circuit breakers (resettable)

1 Motor protection circuit breaker for compressor motor

2 Mains circuit breakers (resettable) 4 A (for electronics)

2 Mains circuit breakers (resettable) 10 A (for pump motor)

11. Electrical connections



Notice: Use shielded cables only.
 The shield of the connecting cable is electrically connected to the plug housing.
 The unit ensures safe operation if connecting cables with a maximum length of 3 m are used. The use of longer cables does not affect proper performance of the unit, however external interferences may have a negative impact on safe operation.

RS232 serial interface

This port can be used to connect a computer with an RS232 cable for remote control of the recirculating cooler.

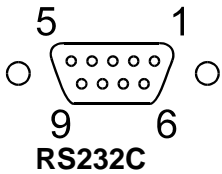

Pin assignments:

Pin 2	RxD	Receive Data
Pin 3	TxD	Transmit Data
Pin 5	0 VD	Signal GND
Pin 6	DTR	Data terminal ready
Pin 7	RTS	Request to send
Pin 8	CTS	Clear to send

Accessories:

Order No.	Description
8 980 073	RS232 interface cable 9-pol./9-pol. , 2,5 m
8 900 110	USB interface adapter cable

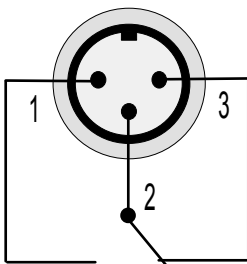

Alarm output

Potential-free change-over contact for external alarm signal.

Pin 2 and 3 are connected in case of an alarm.
 Pin 2 and 1 are connected in "OFF" or "rOFF" condition or mains switch "Off".

Switching capacity	max.	30 W / 30 VA
Switching voltage	max.	30 V~/–
Switching current	max.	1 A

12. Remote control

12.1. Setup for remote control



RS232

Check the interface parameters for both interfaces (on recirculating cooler and PC) and make sure they match.

Interface parameters are pre-determined.

Type	RS232
Baudrate	4800 bauds
Parity	even
Handshake	hardware handshake

12.2. Communication with a PC or a superordinated data system

If the recirculating cooler is put into remote control mode the MULTI-DISPLAY (LED) will read „R -OFF-„ = REMOTE STOP. The recirculating cooler is now operated via the computer.

In general, the computer (master) sends commands to the recirculating cooler (slave). The recirculating cooler sends data (including error messages) only when the computer sends a query.



In remote control mode:

After a power interruption the order to start and all values which have to be adjusted must be resent from the personal computer via the interface. AUTOSTART is not possible.

A transfer sequence consists of:

- command out/in command
 - space (↔; Hex: 20) out/in command
 - parameter (the character separating decimals in a group is the period) out command
 - end of file (↵; Hex: 0D) out/in command
- The response (data string) after an **in** command is always followed by a line feed (LF, Hex: 0A).

Important times for a command transmission:

To ensure a safe data transfer, the time gap between two commands should be at least 250 ms.

The recirculating cooler automatically responds to an **in** command with a data string followed by a LF (Line Feed). The next command should only be sent after 10 ms.



The commands are divided into **in** or **out** commands.

in commands: asking for parameters to be displayed
out commands: setting parameters



The **out** commands are valid only in remote control mode.

Examples:

Command to set the working temperature to 15,5 °C:

out_sp_00 ↔ 15.5↵

Command to ask for the working temperature

in_sp_00↵

Response from the recirculating cooler:

15.5↵ LF

12.3. List of commands

out commands: Setting parameters or temperature values.

Command	Parameter	Response of recirculating cooler
out_mode_05	0	Stop the unit = R –OFF–.
out_mode_05	1	Start the unit.
out_sp_00	xxx.xx	Set working temperature

in commands: Asking for parameters or temperature values to be displayed.

Command	Parameter	Response of recirculating cooler
version	none	Number of software version (V X.xx)
status	none	Status message, error message (see page 24)
in_pv_00	none	Actual bath temperature.
in_sp_00	none	Working temperature
in_mode_05	none	Recirculating cooler in Stop/Start condition: 0 = Stop 1 = Start

12.4. Status messages

Status messages	Description
00 MANUAL STOP	Recirculating cooler in „OFF“ state.
01 MANUAL START	Recirculating cooler in keypad control mode.
02 REMOTE STOP	Recirculating cooler in „r OFF“ state.
03 REMOTE START	Recirculating cooler in remote control mode.

12.5. Error messages

Error messages	Description
-01 LOW LEVEL ALARM	Low liquid level alarm.
-05 WORKING SENSOR ALARM	Working temperature sensor short-circuited or interrupted.
-03 EXCESS TEMPERATURE WARNING	High temperature warning. Starting at 75 °C (no deactivation) The return temperature soon reaches the switch-off value of the high temperature warning function (85 °C)
-07 I²C-BUS ERROR	Internal error when reading or writing the I ² C bus.
-08 INVALID COMMAND	Invalid command.
-09 COMMAND NOT ALLOWED IN CURRENT OPERATING MODE	Invalid command in current operating mode.
-10 VALUE TOO SMALL	Entered value too small.
-11 VALUE TOO LARGE	Entered value too large.
-12 TEMPERATURE MEASUREMENT ALARM	Error in A/D converter.
-14 EXCESS TEMPERATURE PROTECTOR ALARM	The return temperature is above the switch-off value of the high temperature warning function of 85 °C. Check dimensioning of application. Use a stronger recirculating cooler if necessary.
-20 WARNING: CLEAN CONDENSOR OR CHECK COOLING WATER CIRCUIT OF REFRIGERATOR	Cooling of the condenser is affected. Clean air-cooled condenser. Check the flow rate and cooling water temperature on water-cooled condenser.
-51 PRESSURE SENSOR ALARM LOW PRESSURE SIDE	The pressure sensor of low pressure side (evaporation pressure) is faulty, short-circuited or has a line interruption. Have the repair done by a specialist.
-52 PRESSURE SENSOR ALARM HIGH PRESSURE SIDE	The pressure sensor of high pressure side is faulty, short-circuited or has a line interruption. Have the repair done by a specialist.
-53 SUCTION GAS TEMPERATURE SENSOR ALARM	The suction gas temperature sensor is faulty, short-circuited or has a line interruption. Have the repair done by a specialist.

13. Cleaning / repairing the unit



Caution:

Always turn off the unit and disconnect the mains cable from the power source before cleaning the unit.
Prevent humidity from entering into the circulator.
Electrical connections and any other work must be performed by qualified personnel only.



Notice:

Risk of injury for hands when mounting the venting grid.

Maintaining the cooling performance

Air cooled models = FL

To maintain the full cooling performance, clean the condenser from time to time.

- Switch off the unit, disconnect mains power cable.
- Hold the venting grid, pull out and remove.
- Clean the ribbed condenser with a vacuum cleaner.
- Replace the venting grid.
- Switch on the unit.

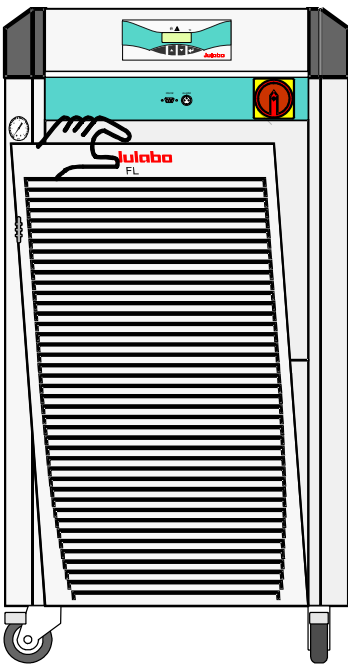

Water cooled models = FLW

In order to maintain a good condition of the cooling compressor, the sieve in the cooling water input should be cleaned in regular intervals.

- Switch the unit off, disconnect the power plug.
- Interrupt the cooling water input.
- Disconnect the tubing from the nozzle „IN“ and take out the dirty sieve.
- Clean the sieve.
- Put in the sieve and reconnect the tubing.
- Open the cooling water input.
- Take care the tubing connection is not leaking.
- The unit is ready to operate again.

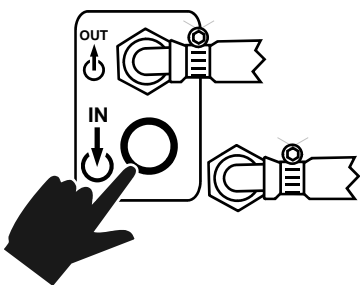

Cleaning:

Clean the outside of the unit using a wet cloth and low surface tension water.

The recirculating cooler is designed for continuous operation under normal conditions. Periodic maintenance is not required.

The tank should be filled only with a bath fluid recommended by JULABO. To avoid contamination, it is essential to change the bath fluid from time to time.

Repairs:

Before asking for a service technician or returning a JULABO instrument for repair, please contact an authorized JULABO service station.

When returning the unit:

- Clean the unit in order to avoid any harm to the service personnel
- Attach a short fault description.
If you intend to return your JULABO unit to us, you will find a Service Return Form on our website www.julabo.de . Please use this as a delivery note and include it to the unit or send it in advance either by Fax or E-Mail.
- When returning a unit, take care of careful and adequate packing.
- JULABO is not responsible for damages that might occur from insufficient packing.



JULABO reserves the right to carry out technical modifications with repairs for providing improved performance of a unit.

13.1. JULABO Service – Online remote diagnosis

JULABO circulators of the HighTech series are equipped with a so-called black box. This box is implemented in the controller and records all significant data for the last 30 minutes. In case of a failure, this data can be read out from the unit by using special software. The respective program is available for free download from www.julabo.de \ EasyBlackBox.

- Installation is easy and carried out step by step. Please observe the instructions.
- Data read-out is possible in the conditions „OFF“, „R OFF“ or „ALARM“.
- Connect the circulator to the computer using an interface cable.
- Start the EasyBlackBox program. The program asks for the used port (COM1,) and the baud rate of the unit. You do not have this information on hand? Simply try it out! The program keeps on sending this request until the actually used port and correct baud rate are entered.

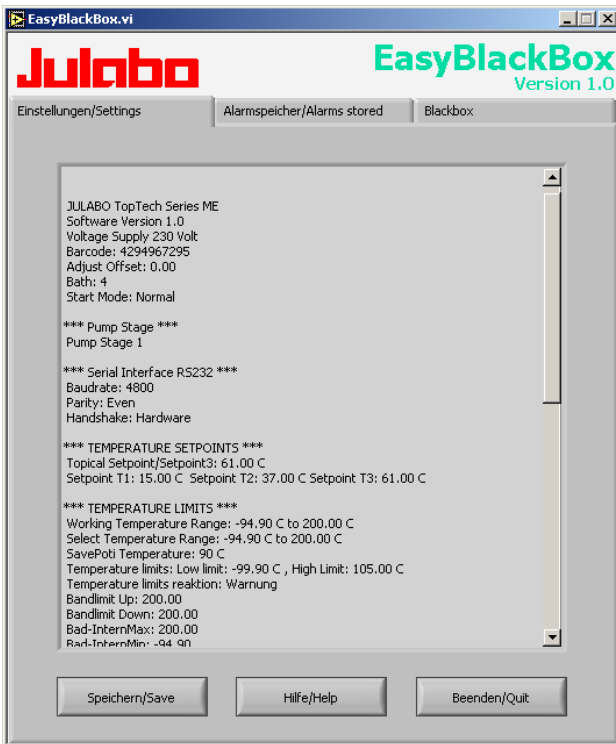

- Data is read out and shown on the monitor divided in the sections >Einstellungen/Settings<, >Alarmspeicher/Alarms stored<, >Blackbox<
- ← see example
- After pressing >Speichern/Save< a text file is compiled. The program proposes a filename - >C:\model description and barcode no.<. Modifications are possible.
- E-mail this file to service@julabo.de, JULABO's service department. JULABO is thus able to provide rapid support.

13.2. Draining



Notice:

Store and dispose the used bath fluid according to the laws for environmental protection.



Risk of injury for hands when mounting the venting grid.

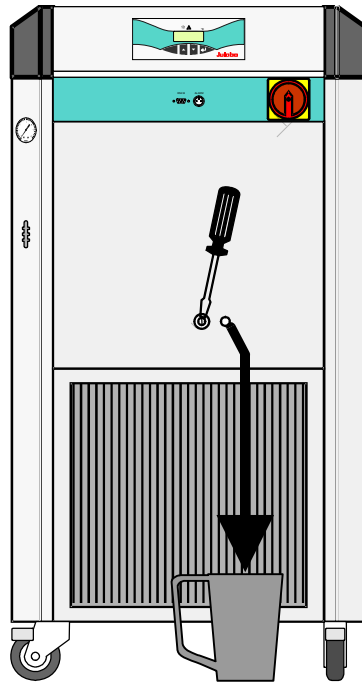
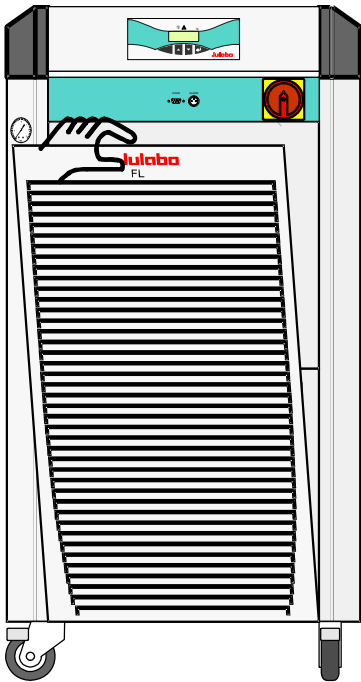

- Turn off the unit and disconnect the mains cable from the power source.
- Hold the venting grid, pull out and remove.
- Slide a short piece of tube onto the drain port and hold it into a pail.
- Open the drain tap and empty the unit completely.
- Close the drain tap and replace the venting grid.

14. Adequate storing of operating manual

Store the operating manual at the foreseen place at the unit and lock it by means of the protection lid (18).

15. Warranty conditions

JULABO Labortechnik GmbH warrants its products against defects in material or in workmanship, when used under appropriate conditions and in accordance with appropriate operating instructions

for a period of ONE YEAR.

Extension of the warranty period – free of charge



With the '1PLUS warranty' the user receives a free of charge extension to the warranty of up to 24 months, limited to a maximum of 10 000 working hours.

To apply for this extended warranty the user must register the unit on the JULABO web site www.julabo.de, indicating the serial no. The extended warranty will apply from the date of JULABO Labortechnik GmbH's original invoice.

JULABO Labortechnik GmbH reserves the right to decide the validity of any warranty claim. In case of faults arising either due to faulty materials or workmanship, parts will be repaired or replaced free of charge, or a new replacement unit will be supplied.

Any other compensation claims are excluded from this guarantee.